

0+1+2+3+4+5

m

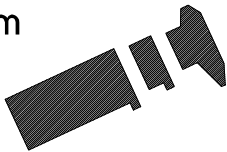

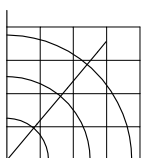

5.64 — 13.14





6

DIN

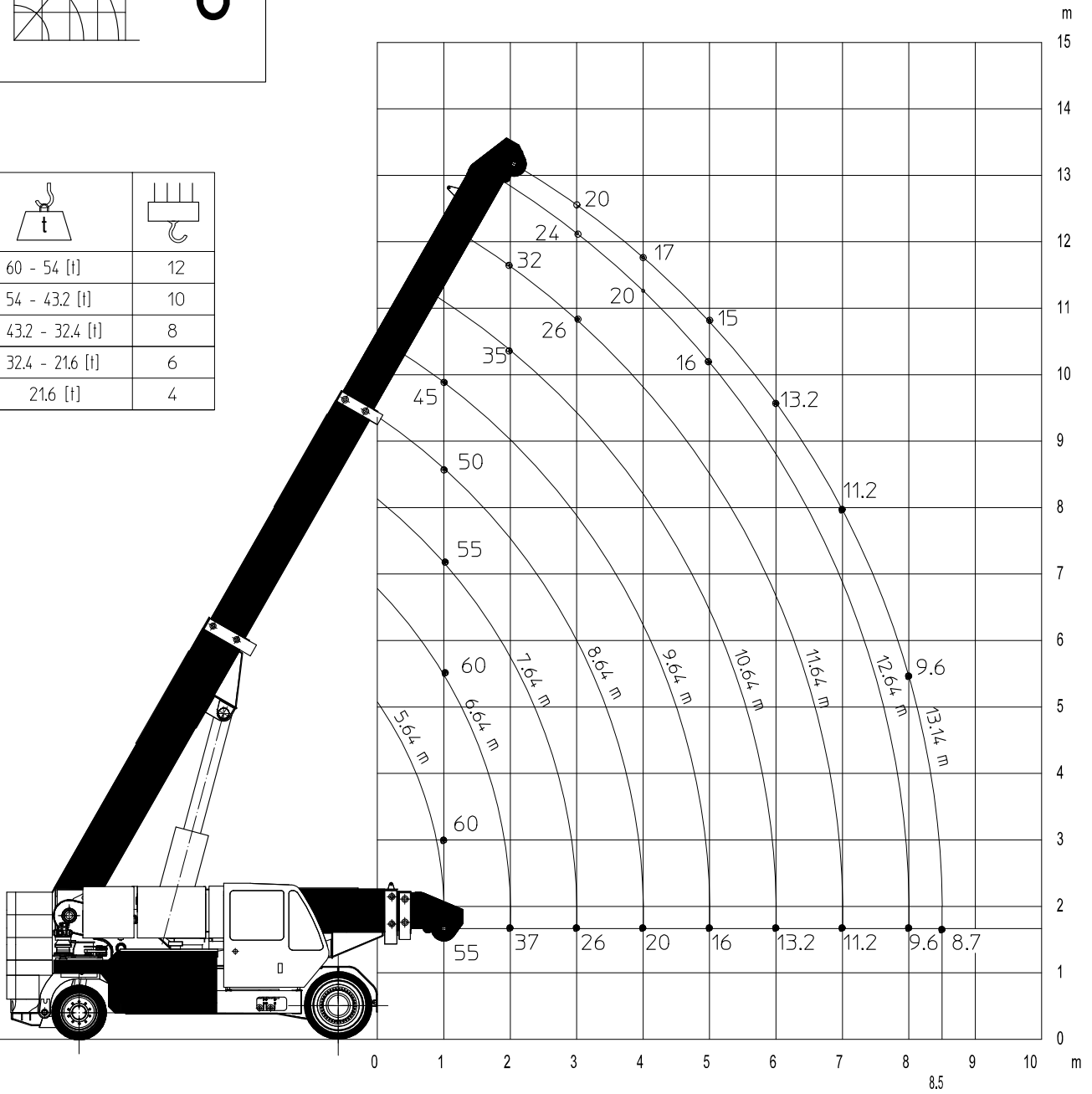
	
60 - 54 [t]	12
54 - 43.2 [t]	10
43.2 - 32.4 [t]	8
32.4 - 21.6 [t]	6
21.6 [t]	4



		
48 km/h	1 km/h	1 km/h